

L Series Battery Fuel Gauge & Volt Meter by GDI

Added features for charger communications, LED Flash Alert™, and more!

Available for 12, 24, 36, or 48 volt DC systems



Features:

- NEW FEATURE: FULLY LIT DISPLAY. New gauges are able to light all ten LED's at once for a bright display that is easy to read in any environment.
- Available as Battery Fuel Gauge, or Volt Meter
- LED Flash Alert™ for low charge & high charge warning, or over voltage & under voltage
- Power up configurable for instant charge level display or traditional count down algorithm
- Memory option to recall last charge level
- Keyswitch Display enable option
- Equipment lockout option
- Communications with equipment charger to display battery level during charging, error codes, and more



Operation of the Battery Fuel Gauge:

Battery Charge capacity is indicated using a 10 segment LED bar graph display from full (right LED segment lit) to empty (Left LED segment lit).

- LED Flash Alert™ flashes the 2nd LED from the left as a warning that the battery has discharged 70%.
- At 80% discharge, LED Flash Alert™ alternate flashes the left 2 LEDs to indicate very low capacity is remaining.
- The LED Flash Alert™ can be OEM customized.
- OEM options include external LED light enable, and charger communication protocol.

Operation of the LED Volt Meter:

The appropriate system voltage is displayed using a 10 segment LED bar graph display.

- The LED Flash Alert™ can be OEM specified.
- The LED Flash Alert™ warns the user that the equipment voltage is approaching a critical voltage range (high or low).

All Battery Fuel Gages and Volt Meters are 100% epoxy encapsulated for superb environmental durability. Four panel mount case styles are available and are designed to fit industry standard cutouts.

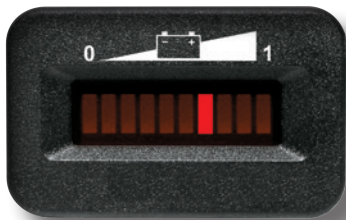

Mini Snap-in

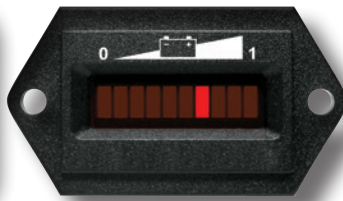

Two Hole

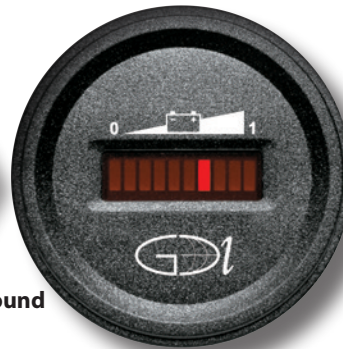

Round



Rectangular Snap-in

Fuel Gauge Features

- Available in 12, 24, 36, and 48 volt or custom DC ranges
- 10 segment LED Bar Graph display
- Resolution: 10% per LED segment.
- Current Draw: 3.2 mA LED Display off, 15 mA with LED Display ON
- Reverse Polarity Protected
- 0.187" faston tabs for easy hookup
- LED enable input to save battery current
- 70% discharge indicated by the 2nd LED segment flashing
- 80% discharge indicated by the 2 left LED segments flashing
- 3 Discharge profiles available, plus Custom profiles
- Power up to instant charge level, or traditional countdown
- Overcharge protected (50% over nominal voltage)
- Full charge indicated when the Top LED bar is lit (specified full charge voltage per cell is reached for a minimum of 6 minutes continuously).

Volt Meter

- Available in 12, 24, 36, and 48 volt or custom DC ranges
- 10 segment LED Bar Graph display
- Resolution: 1 Volt per Bar (or OEM specified).
- Accuracy: +/- 0.12 volts DC
- Current Draw: 15mA
- Reverse Polarity Protected

Environmental Specifications

- Operating temperature: -40F to 160F (-40C to 71C)
- Shock: SAE J1378 55g's
- Vibration: SAE J1378 20g's
- Humidity: SAE J1378 95% RH
- 100% Epoxy encapsulated
- Case Material: ABS, black or white
- Weight 1 oz.
- Warranty: Two years for OE

Model	Bezel Style	Input	Termination	BDI Discharge Code	Battery Voltage	SenDEC Code
L1	I = Rectangular J = Mini (snap in) K = Two Hole L = Round	1 BDI or Volt	2 = (2) 0.187 faston tabs 3 = (3) 0.187 faston tabs 4 = (4) 0.187 faston tabs	197 * 204 * 202 * Custom *	A = 12vdc Internal B = 24vdc C = 36vdc D = 48vdc	Factory Assigned

Part number example:

L1J-13-197B L1 = Battery meter, J = Mini bezel, -1 = Battery Discharge Indicator, 3 = (3) 0.187 fastons, - 197 = a 1.97 volts p/ cell full charge curve, B = 24vdc fuel gauge per cell empty

* BDI Standard Discharge profiles: (Custom profiles available)

197 = (1.97 vpc at full charge, 1.75 vpc at empty)

204 = (2.04 vpc at full charge, 1.73 vpc at empty)

202 = (2.02 vpc at full charge, 1.85 vpc at empty)

Custom

* Volt Meter

Customer High or Low warnings available

**Volt Meter is selected at the Factory

OEM Options

- Lockout function to disable vehicle operation when the battery is dangerously low.
- Other battery voltages available
- Custom discharge curves available
- Custom Logos
- Packaging: Individual box, bulk in trays, poly-bagged or special kits.

Display Enable Hookup:

Note: Other hookups available depending on options

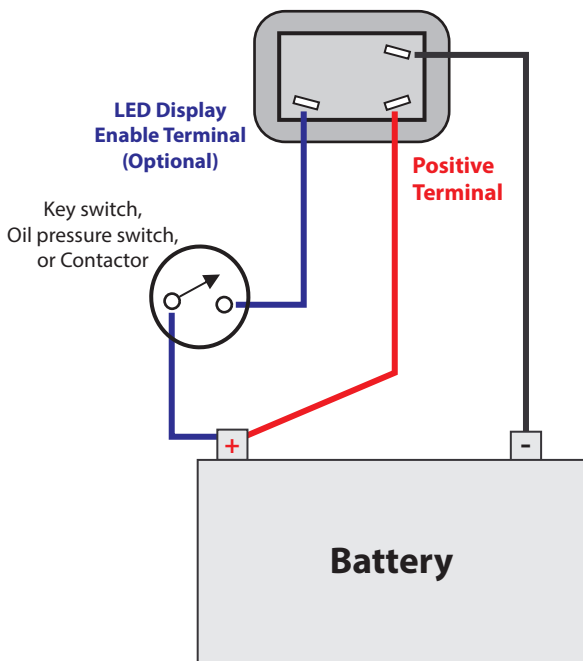

Rectangular Snap-In

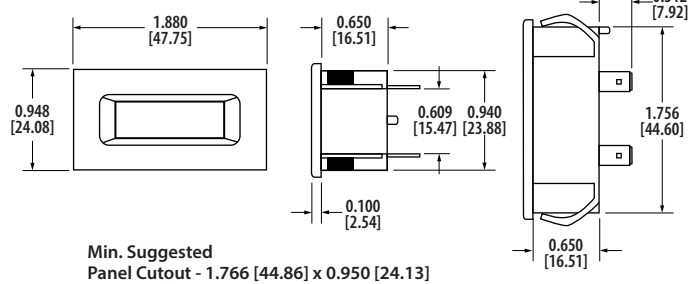

Mini Snap-In

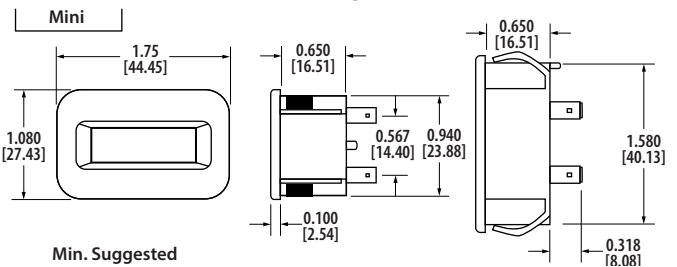

Two Hole

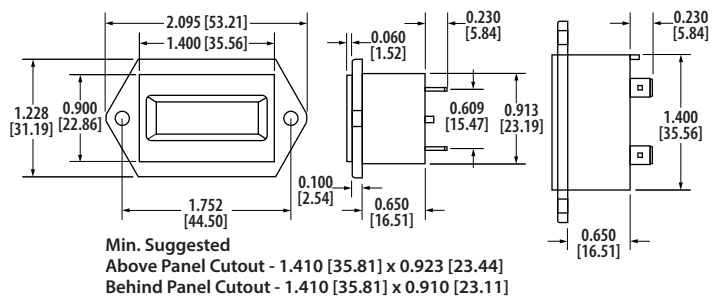

Round

