

# Vibration Hour Meter FOR ANY VIBRATING EQUIPMENT





## Displays Only Full Hours

Surface Mount  
Series N151  
Model Code N151 0101 0184 0003



IMD Europe GmbH · Auf dem Molzberg 2 · D-57548 Kirchen

### Quality Features

-  Absolut dust-, fresh-, & saltwater resistant till 20m underwatersurface.
-  Due to a self-contained battery it has a life cycle of 12 years.
-  Extrem shock proof up to at least 90G
-  High contrast LCD display is always lit and is polarized to prevent discoloration from UV exposure.
-  Pressure washer cleaning possible.

### Product Pictures

Top View



Perspective View



### Mechanical Specification

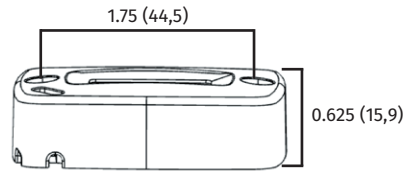
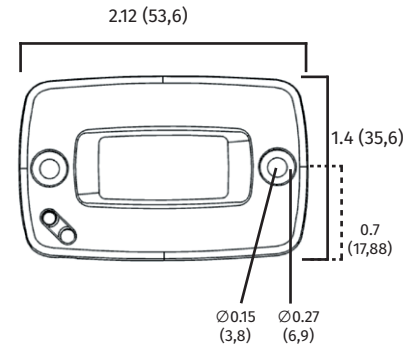

imperial (metric)

### OEM and Packaging

Blister Card Design Pack.  
All hardware included.

- Hour Meter
- Screws
- Manual
- Double sided tape



### Apply for

For any equipment with regular vibration.

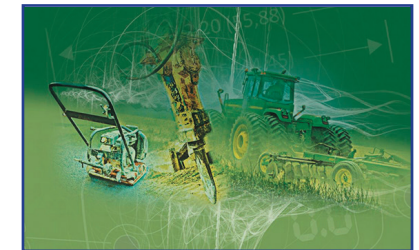

### Integrated Functions

for N151 0101 0184 0003  
Full Hours only

With Transport Filter  
With Event Counter

No Timer  
No Service Alerts

### Transport Filter



During the first sec. after start of the engine it will check out if there is a constant frequency. Therefore the meter adds detecting sec. behind time to determine the real operating hours.  
Does not count when random vibration applies.

### Instruction

Activation: Keep the menu button pressed until the code number is replaced by 0000.0.  
Event counter: Hold down the menu button for 10 sec. The displayed number is the number of on / off events.

